

TRACK 48Vdc 02 SOSPENSIONE - SUSPENSION

9L007,9L008,9L009

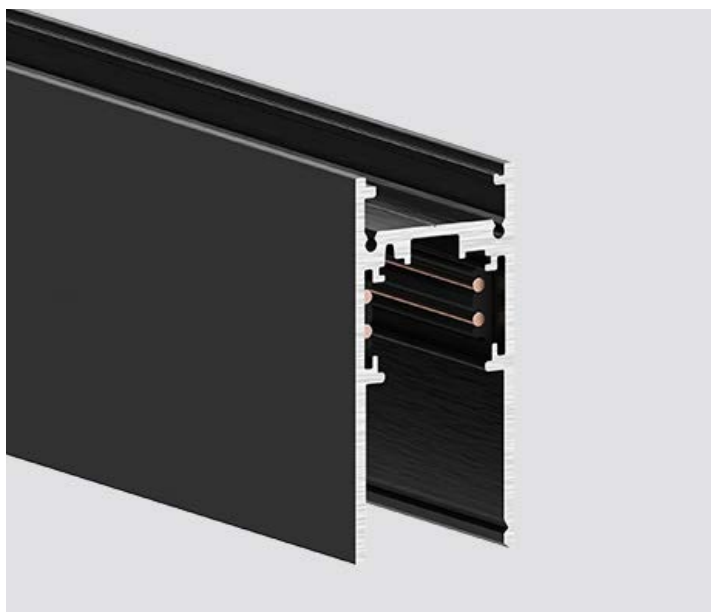

Descrizione del prodotto / Product description

Binario elettrificato a bassa tensione per installazione a sospensione.
Possibilità di doppia emissione.
Realizzato in alluminio estruso.
Conduttori interni isolati in rame.
Corpo verniciato a polveri epossidiche con un'ampia versatilità d'uso grazie alla vasta offerta di accessori dedicati.

*Low voltage electrified track for pendent.
Possibility of double emission.
External body made of extruded aluminium.
Copper internal conductors.
Body painted with epoxy powders with a wide versatility thanks to the wide range of dedicated accessories.*

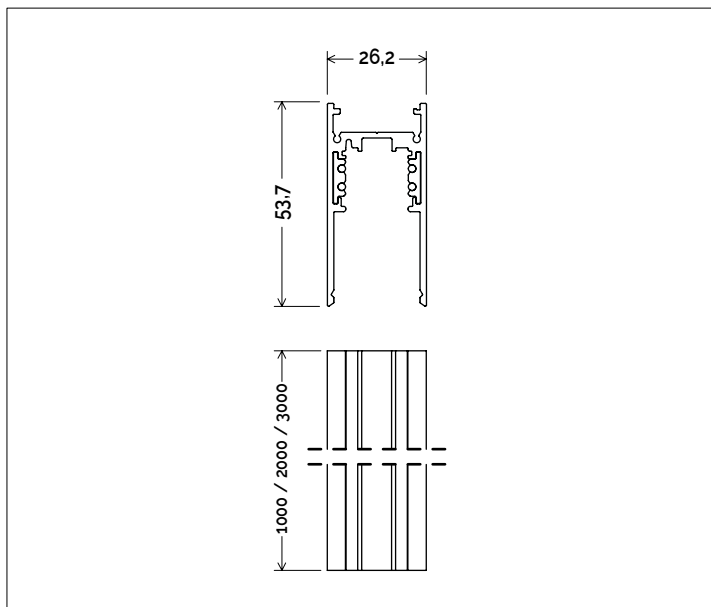

Dati tecnici | Technical Info

* su richiesta / on requests

Finiture | Finishes

- **4001** Bianco | White
- **4002** Nero | Black
- Verniciati RAL | RAL Paintings*

Lunghezza | Length

- 9L007** 1m
- 9L008** 2m
- 9L009** 3m

Corrente | Current

15A

Tensione | Voltage

24 ~ 48Vdc

Temperature di esercizio | Operating temperature

-20° ~ 45°

Simbologia tecnica Technical informations

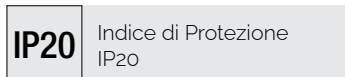
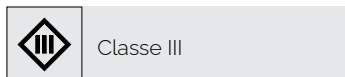
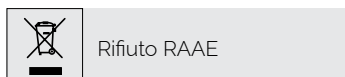
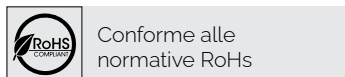
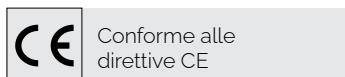

Sistemi di Controllo Control System



Accessori | Accessories

9L101-XXXX

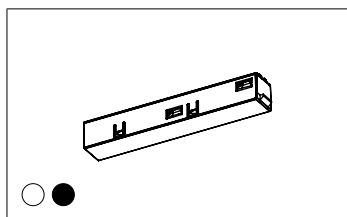

Testata di alimentazione
(110x17x17mm).

Colore bianco o nero.

*Power Head (110x17x17mm).
Color white or black.*

9L102-XXXX

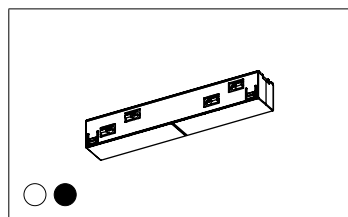

Giunto diretto (110x17x17mm).
Colore bianco o nero.

*Direct Joint (110x17x17mm).
Color white or black color.*

9L103-XXXX

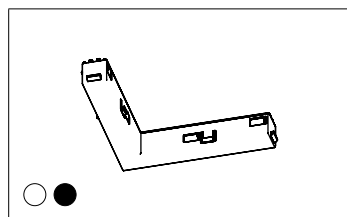

Giunto Angolare (110x110x17mm)
Colore bianco o nero.

*Corner Joint (110x110x17mm).
Color white or black color.*

9L104-XXXX

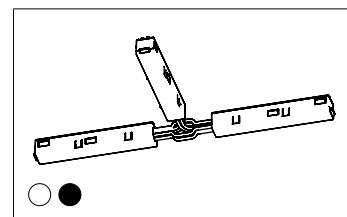

Giunto a T (278x147x18mm).
Colore bianco o nero.

*T Joint (278x147x18mm).
Color white or black.*

9L105-XXXX

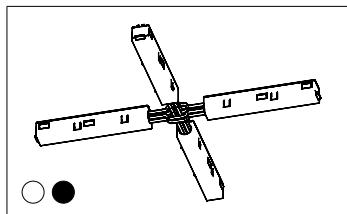

Giunto a X (278x278x18mm).
Colore bianco o nero.

*X Joint (278x278x18mm).
Color white or black.*

9L106-XXXX

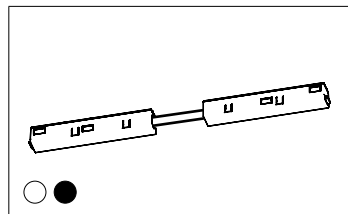

Giunto flessibile (270x17x17mm).
Colore bianco o nero.

*Flexible Joint (270x17x17mm).
Color white or black.*

9L111-XXXX

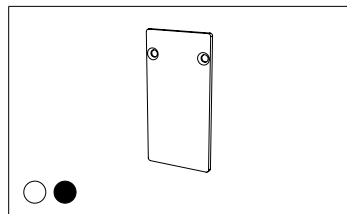

Tappi di chiusura (26x54mm).
Colore bianco o nero.

*End cap (26x54mm).
Color white or black.*

9L112-XXXX

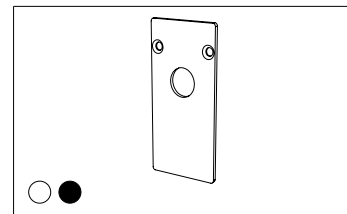

Tappi di chiusura con foro
(26x54mm). Colore bianco o
nero.

9L113-XXXX

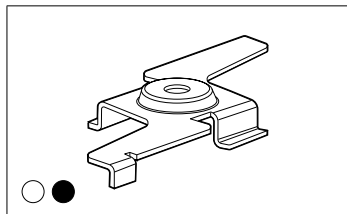

Clip per fissaggio a soffitto.
Colore bianco o nero.

*Ceiling fixing clip.
Color white or black*

9L114-XXXX

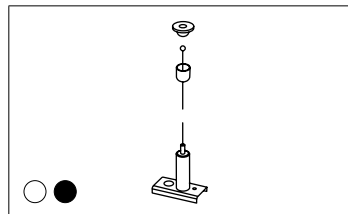

Kit per fissaggio a sospensione.
(cavo sospensione 1,5m).
Colore bianco o nero.

*Suspension fixing kit.
(suspensione cable 1,5m).
Color white or black.*

9L115-XXXX

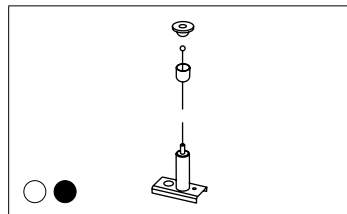

Kit per fissaggio a sospensione.
(cavo sospensione 3m).
Colore bianco o nero.

*Suspension fixing kit.
(suspensione cable 3m).
Color white or black.*

9L121-XXXX

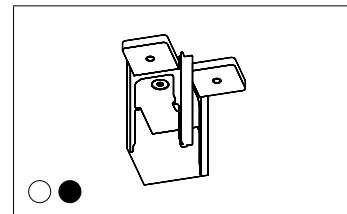

Cover Giunto a L (53x53x26mm).
Colore bianco o nero.

*L Joint Cover (53x53x26mm).
Color white or black color.*

9L122-XXXX

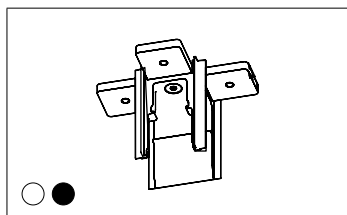

Cover Giunto a T (78x53x26mm)
Colore bianco o nero.

*T Joint Cover (78x53x26mm)
Color white or black.*

9L123-XXXX

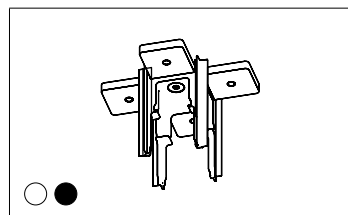

Cover Giunto a X (78x78x26mm).
Colore bianco o nero.

*X Joint Cover (78x78x26mm).
Color white or black.*

Codici Ordine | *Order Code*

finitura / finishes	lunghezza / lenght	codice / code
○ 4001 Verniciato Bianco <i>White painted</i>	1m	gL007-XXXX
● 4002 Verniciato Nero <i>Black painted</i>	2m	gL008-XXXX
	3m	gL009-XXXX