

BULLETTA APPLIQUE

353SA01H51



Descrizione del prodotto / Product description

Applique LED per esterni.
Corpo dissipante interno in alluminio
realizzato in alluminio tornito
verniciato a polvere.
Optica ad emissione diffusa.
CRI ≥90.
Fornito con sistema di connessione
IP67.
(vedi istruzioni di montaggio).
on/off-TRIAC a bordo.

Outdoor LED wall light.
Internal dissipating body in aluminum
made of turned and powder-coated aluminum.
Diffused emission optics.
CRI ≥90.
Supplied with IP67 connection system.
(see assembly instructions).
on/off-TRIAC driver included

Dati tecnici | Technical Info

* su richiesta / on requests

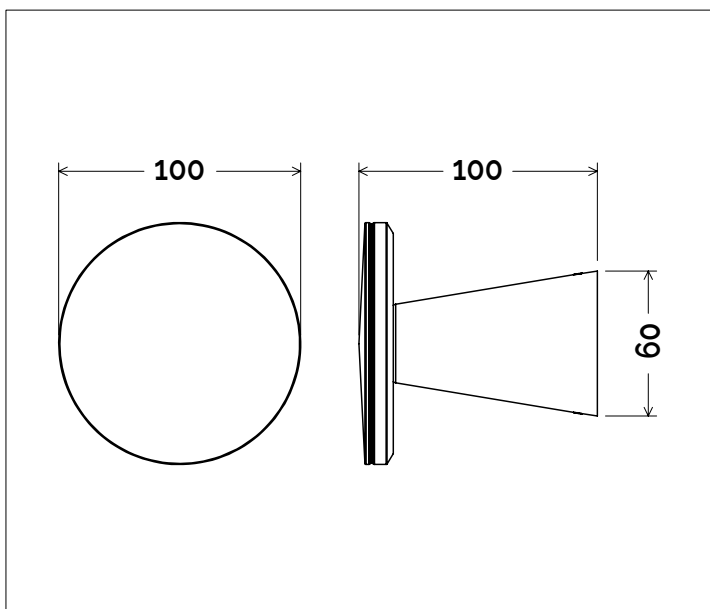

Finiture Finishes	Colori
4003	Grafite Graphite
4004	Cemento Concrete
4006	Corten Scuro Dark Corten
4008	Verde Scuro Dark Green
4015	Bianco Fiorentino Flore. White
4024	Rosso Bolgheri Bolgheri Red
1041	Lam. Rame Lam. Copper
1042	Lam. Ottone Lam. Brass

Potenza Power	5W
Corrente Current	-
Tensione Voltage	220-240VAC
Tolleranza cromatica Chromatic tolerance	3 SDCM
Flusso luminoso Luminous Flux	450lm
Mantenimento del flusso luminoso Flux Maintenance	≥50.000h
Temperature di esercizio Operating temperature	-20° ~ 45°

Simbologia tecnica Technical informations

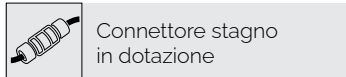
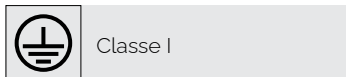
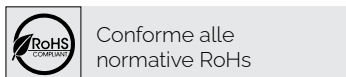
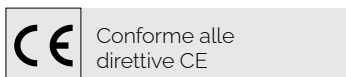

Temperatura di Colore Color Temperature

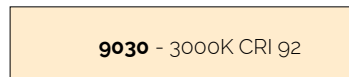
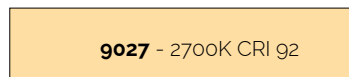

Ottiche Optics

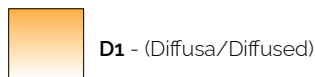

Sistemi di Controllo Control System



Creazione Codice | Code construction

353SA01H51-XXXX-XX-XXXX

