

CALLA CC FISSAGGIO BASE / CANOPY FIXING

352PA02C11



Descrizione del prodotto / Product description

Proiettore LED direzionabile da interno con rosone per fissaggio a soffitto.

Ideale per l'illuminazione d'accento.

Corpo lampada realizzati in alluminio tornito con verniciatura a polvere epossidica.

Snodo in ottone tornito e base verniciata.

Disponibili varie ottiche in PMMA trasparente.

Fornito con connettore a due poli (vedi istruzioni di montaggio).

Adjustable indoor LED projector with ceiling rosette.

Ideal for accent lighting.

Lamp body made of turned aluminum with epoxy powder coating.

Turned brass joint and painted base.

Various transparent PMMA optics available.

Supplied with two-pole connector

(see assembly instructions).

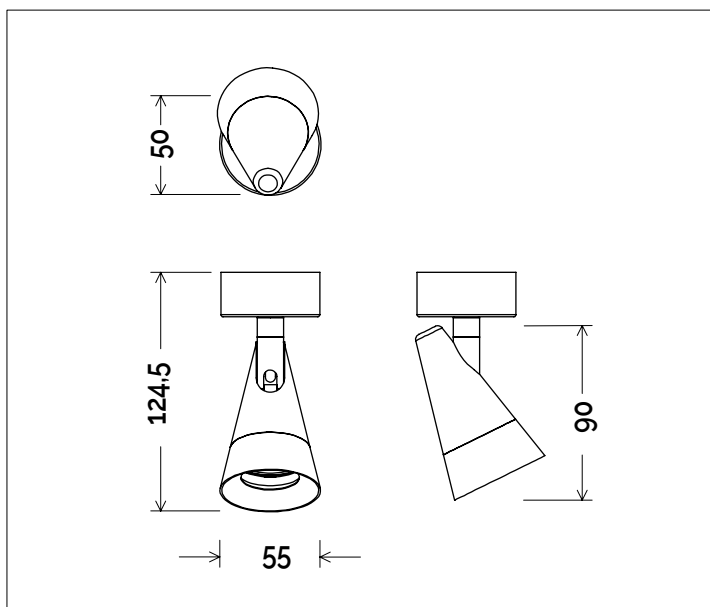

Dati tecnici | Technical Info

* su richiesta / on requests

Finiture Finishes	4001 Bianco White
	4002 Nero Black
	4010 Oro Gold
	4011 Bronzo Bronze
	Verniciati RAL RAL Paintings*
Potenza Power	6W
Corrente Current	350mA
Tensione Voltage	18Vdc
Tolleranza cromatica Chromatic tolerance	3 SDCM
Flusso luminoso Luminous Flux	664lm
Mantenimento del flusso luminoso Flux Maintenance	≥50.000h
Temperature di esercizio Operating temperature	-20° ~ 45°

Simbologia tecnica Technical informations

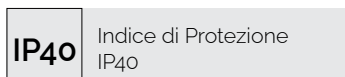
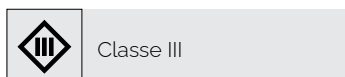
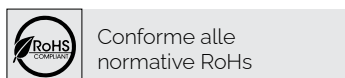
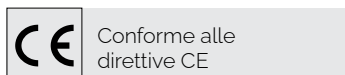

Temperatura di Colore Color Temperature

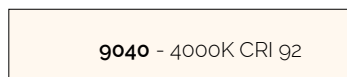
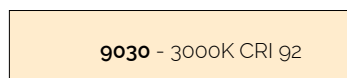
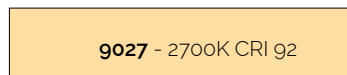

Ottiche Optics

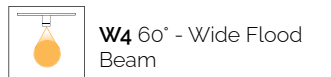
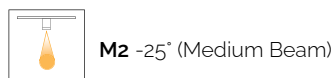
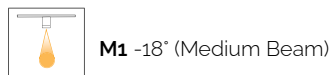

Sistemi di Controllo Control System



Creazione Codice | Code construction

352PA02C11-XXXX-XX-XXXX

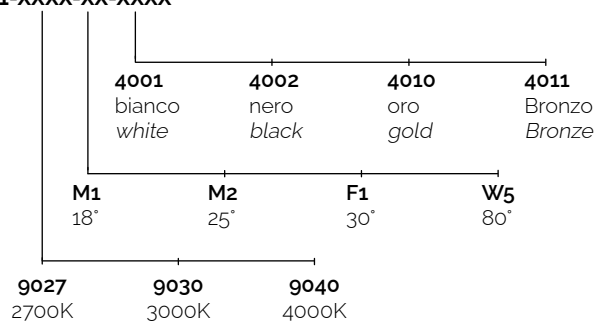

Alimentatori | Led

Tipo Alim. / Driver Type	potenza / power	corrente / current	dimensioni / dimensions	n. prodotti	IP	codice / code
ON/OFF	10W	350mA	22x19x132mm	1	20	9M104
DALI PUSH	16W	350mA	22x20x142mm	1-2	20	9M507/350