

DAMA MINI COMFORT LIGHT

354SA02H51



Descrizione del prodotto / Product description

Plafone LED per interni ed esterni.
Corpo lampada in alluminio
tornito verniciato.

Sorgente COB LED a tensione di
rete.

Fornito con staffa di fissaggio e
sistema di connessione
(vedi istruzioni di montaggio).

Alimentatore on/off-TRIAC a
bordo incluso

Ceiling LED for indoor and
outdoor.

Lamp body made of turned and
painted aluminum.

COB LED 220/240Vac source.

Supplied with fixing bracket and
connector system

(see assembly instructions)

On/off-TRIAC power supply in-
cluded

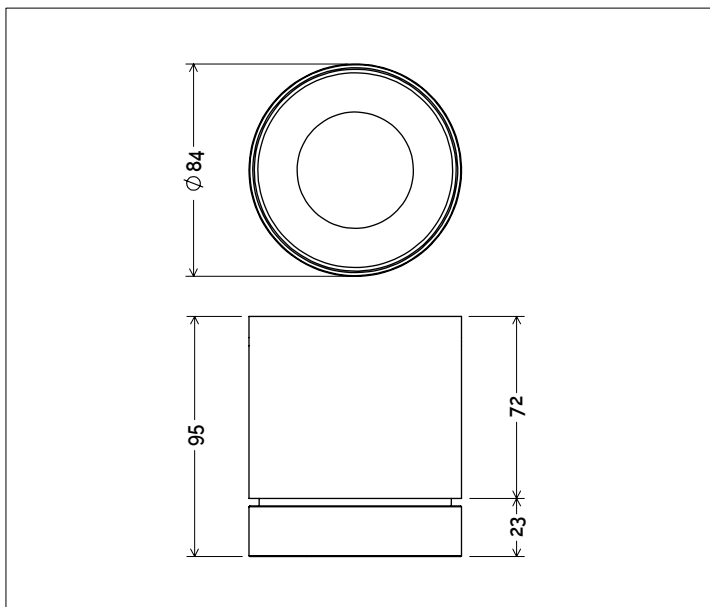

Dati tecnici | Technical Info

* su richiesta / on requests

Finiture Finishes	
	1041 Lam. Rame Lam. Copper
	1042 Lam. Ottone Lam. Brass
	4003 Grafite Graphite
	4004 Cemento Concrete
	4006 Corten Scuro Dark Corten
	4008 Verde Scuro Dark Green
	4015 Bianco Fiorentino Flore. White
	4024 Rosso Bolgheri Bolgheri Red
	Verniciati RAL RAL Paintings*
Potenza Power	8W
Corrente Current	-
Tensione Voltage	220-240Vac
Tolleranza cromatica Chromatic tolerance	3 SDCM
Flusso luminoso Luminous Flux	1073lm
Mantenimento del flusso luminoso Flux Maintenance	≥50.000h
Temperature di esercizio Operating temperature	-20° ~ 45°

Simbologia tecnica Technical informations

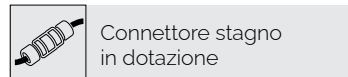
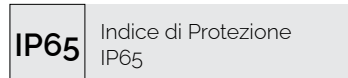
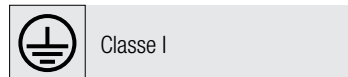
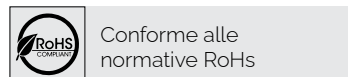
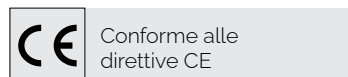

Temperatura di Colore Color Temperature

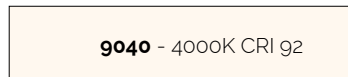
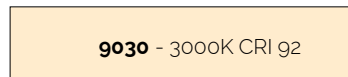
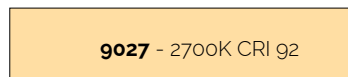

Ottiche Optics

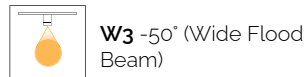
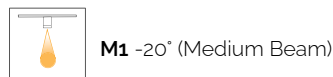

Sistemi di Controllo Control System



Creazione Codice | Code construction

354SA02H51-XXXX-XXXX

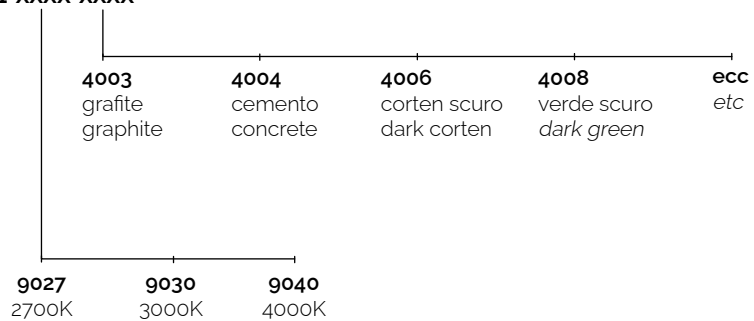

9F011-XX-XXXX

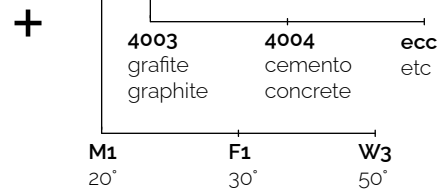

Accessori | Accessories

9F011-XX-XXXX

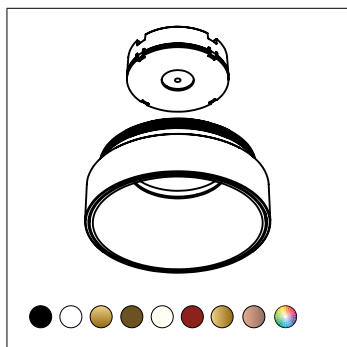

Ottica+Comfort light/

Optic+Comfort light