

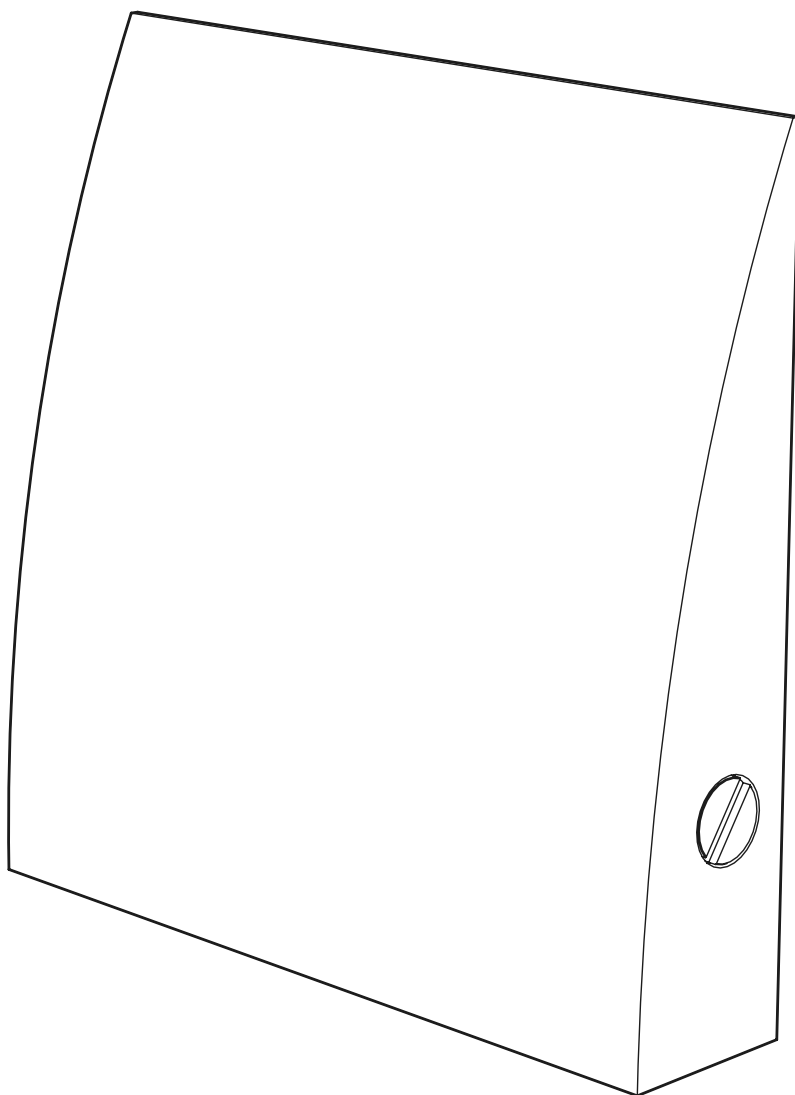

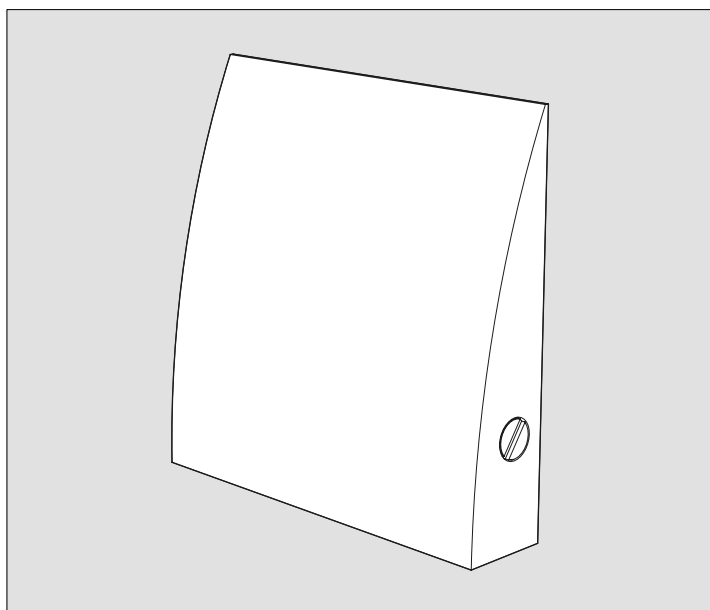



# 304SA01L11

STEP



# 304SA01L11 STEP



 Conforme alle direttive CE	 Classe III
 Conforme alle normative RoHS	 Indice di Protezione IP65
	 Rifiuto RAAE

## Dati tecnici | Technical Info

Potenza   Power	0,8W
Corrente   Current	-
Tensione   Voltage	24Vdc
Flusso luminoso   Luminous Flux	126lm
Mantenimento del flusso luminoso   Flux Maintenance	≥50.000h

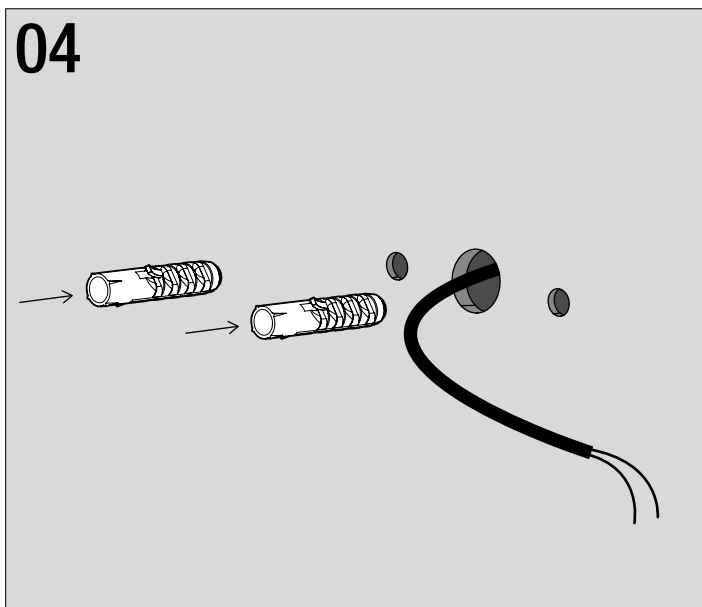
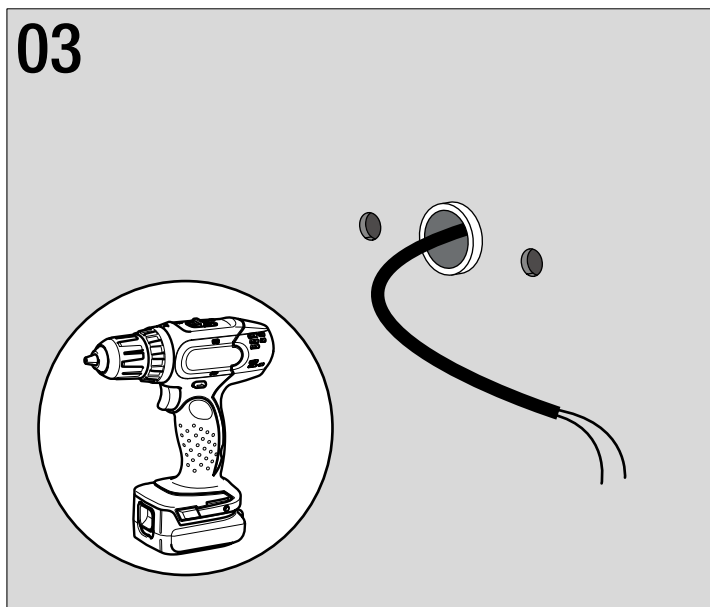
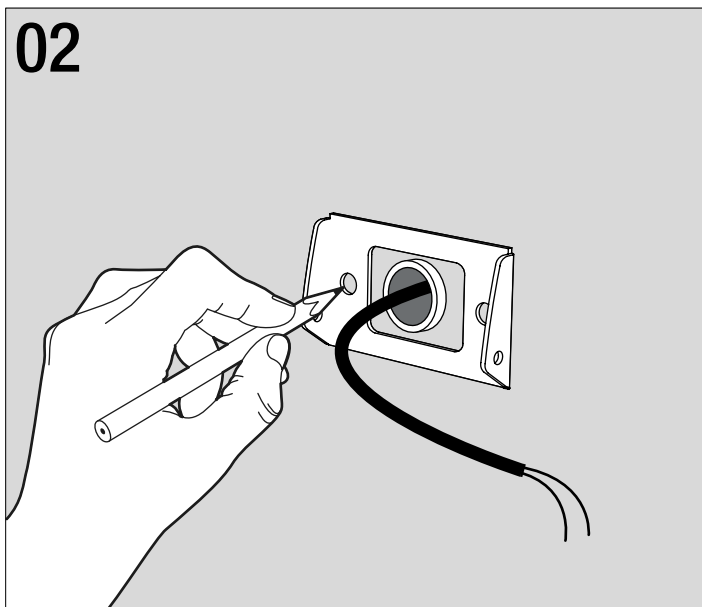
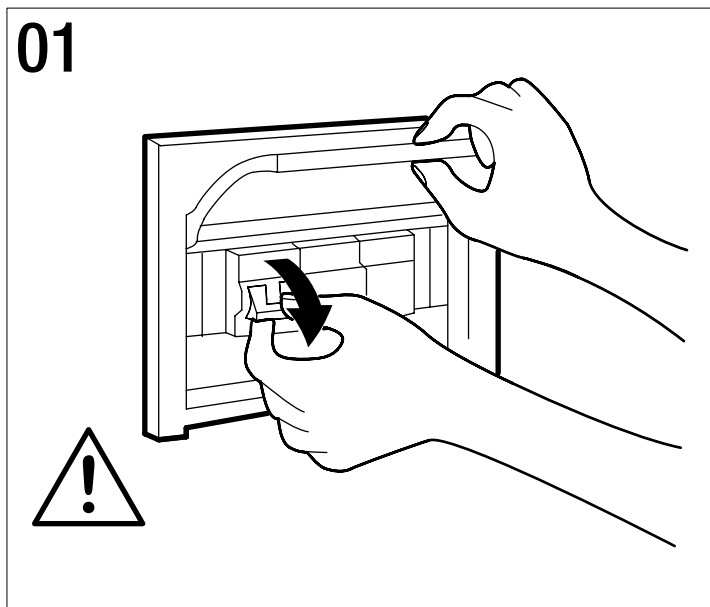

05

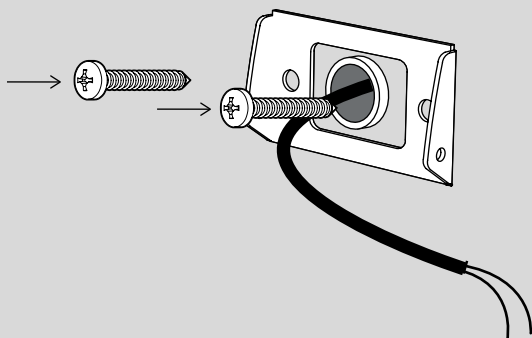

06

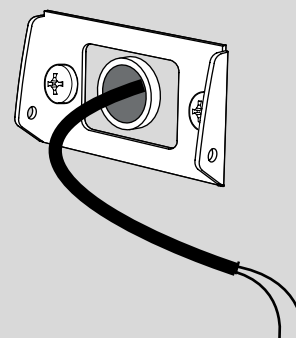

07

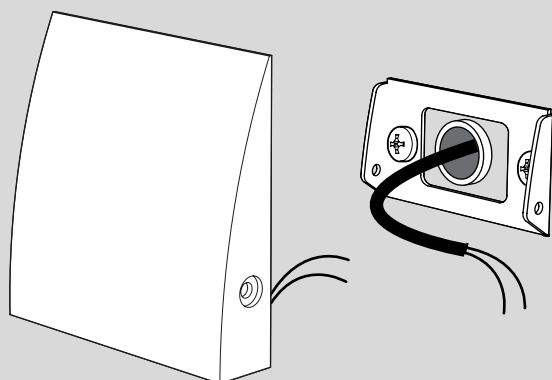

08

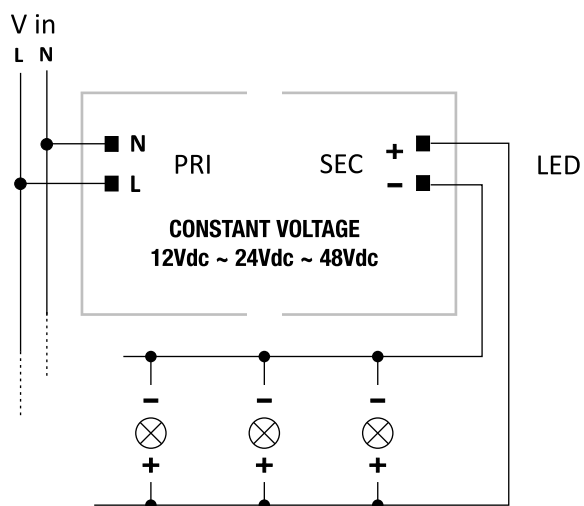

09

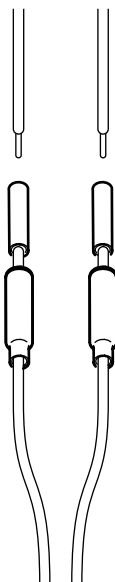

10

